

INSTRUCTION MANUAL

SLIDE 865



S.E.F.A®
Z.I PASTABRAC
11260 ESPERAZA
FRANCE

Tel: 33 (0)4.68.74.05.89 - Fax:33.(0)4.68.74.24.08

Email: contact@sefa.fr

INDEX

INDEX	2
I. CONDITIONS OF GUARANTEE	3
II. SPECIFICATIONS	4
III. OVERVIEW	5
IV. USING THE MACHINE	6
1. SAFETY	6
2. INSTALLATION	7
V. DESCRIPTION OF THE OPERATING CYCLE.....	8
1. COMPLETE CYCLE.....	8
2. CONTROL PANEL	9
VI. DIAGRAMS.....	10
PNEUMATIC DIAGRAM.....	12
VII. MAINTENANCE	13
1. SERVICING.....	13
2. POSSIBLE BREAKDOWNS	14
3. MAINTENANCE LOG	15

I. CONDITIONS OF GUARANTEE

- The guarantee period starts the day of putting the equipment into service at the user's place, materialized by the return of the guarantee bill for a duration of two years, 8h per day meaning about 3000 hours.
- The guarantee is strictly limited to our equipment, against the defects of matter and execution, with the buyer's responsibility to prove the known defects.
- Our responsibility is limited to the obligation to rectify or replace free of charge the parts acknowledged as faulty by ourselves, and there will no claim for any indemnity whatever the reason given.
- Parts replaced under the guarantee:
 - remain our property
 - are the subject of an invoicing of deposit
- A credit of cancellation is activated as soon as the faulty parts are returned.
The return will have to occur ONE MONTH MAXIMUM after the intervention

THE GUARANTEE DOES NOT COVER :

- The retail consumables such as:
 - Fuses, bulbs, joints, flexible devices, covers, nozzles, filters.....
 - The supplies, which are not our own manufacturing, undergo the guarantee of their manufacturer.

THE GUARANTEE DOES NOT APPLY :

- To replacements, nor repairs which would result from normal wear and tear of apparatus and machines, of deteriorations and accidents coming from negligence, defect of monitoring and maintenance, defective use or modifications without our written agreement.
- In case of vice coming from the material supplied by the buyer, or a design imposed by the latter.
- To repairs which would result from deteriorations or accidents occurred during transport.
- To operations of maintenance and adjustments inherent in the use of the machine, and indicated in the maintenance manual, such as:
 - adjustments of intermediaries
 - screwing of piping, etc...



For the pneumatic machines, any trace of detergent oil in the pneumatic circuit inhibits the conditions of guarantee previously mentioned.

**For any technical information or spare parts orders,
please give the reference number of the machine as well as its serial number**

II. SPECIFICATIONS

Poids en ordre de marche / <i>Weight in running order</i>	235 kg
Hauteur / <i>Height</i>	794 mm
Profondeur / <i>Depth</i>	1071 mm
Largeur / <i>Width</i>	893 mm
Dimension du plateau / <i>Dimension of the heating plate</i>	850x650 mm
Alimentation électrique / <i>Electric power supply</i>	400 V + neutral and earth connections 50/60 Hz
Puissance / <i>Power</i>	6 KW
Ampérage / <i>Amperage</i>	9 A
Pression de travail / <i>Working pressure</i>	
Mini	4 bars
Maxi	8 bars
Régulateur électronique de température à affichage digital / <i>Thermoregulator</i>	
Précis à / <i>Accurate to</i>	+/- 1%
Réglable de / <i>Range of control</i>	0 - 230°C
Minuterie électronique / <i>Timer</i>	
Précis à / <i>Accurate to</i>	+/- 1%
Réglable de / <i>Range of control</i>	0 - 99 mn

Non contractual document: according to the technical progress, we reserve the right to modify the characteristics of our products.

Some of these characteristics are recalled on the nameplate you will find on the machine.

S.E.F.A ®	
Z.I PASTABRAC	
11 260 ESPERAZA – (France)	
Tel : +33.(0)4.68.74.05.89	Fax : +33(0)4.68.74.24.08
N° de Série	<input style="width: 100%;" type="text"/>
	<input style="width: 100%;" type="text"/>
Année de Fab.	<input style="width: 100%;" type="text"/>
	

III. OVERVIEW

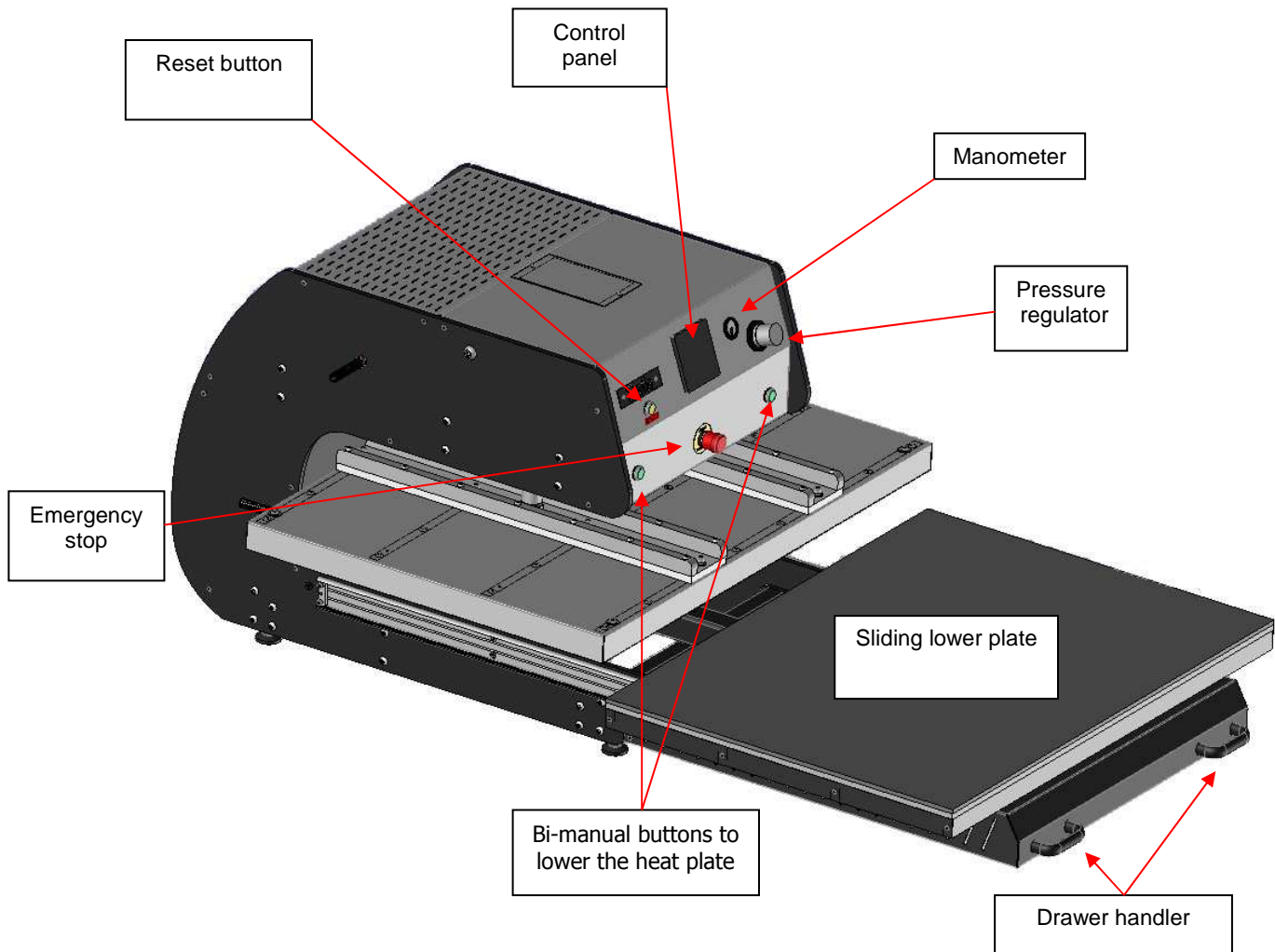

This heat press machine is standard to the labour laws to ensure the security of the user. It is designed to ensure the production with total reliability.

This press was designed for an operator working in front of the machine.

IV. USING THE MACHINE

The SLIDE 865 press was designed for the application of transfers of all grades. This equipment has been tested in our workshops to get two years warranty against manufacturing defects.

Power settings, mechanical and pneumatic submitted by our technicians in the workshop as well as the security established on the machine should never be changed. Otherwise, the SEFA ® company will deny all responsibility on potential problems associated with said machine.





Before starting any pressing operation, it is recommended that you read the safety instructions and the instructions for use.

The press should be used by an authorized person and having been informed of the risks that may be caused by improper use of the equipment





1. SAFETY

THIS EQUIPMENT IS DESIGNED FOR SINGLE USE ONLY

USE BY QUALIFIED STAFF ONLY

International Symbols	
 OFF	 HOT SURFACE
 ON	 ELECTROCUTION RISK
 DANGER, WARNING	

You will find most of these symbols on the SEFA equipment.

- Important point for security :**
-  *Don't touch the hot parts of the equipment while in use.*
 -  *During handling action, ensure the operator does not take any risk in terms of burns, electrocution or other.*
 -  *Proceed with a daily inspection of the machine before starting the production .*
 -  *Make sure nobody is around or near the machine before you start it up.*
 -  *If the machine does not work properly, shut down immediately all energy supplies and search for the cause by using the book's « Maintenance » chapter.*

Security devices installed on the machine



*The protections and security devices should not be modified.
They should be restored in case of removal for maintenance work.
They must be maintained in good running order during the production.*

The press SLIDE 865 is equipped with mechanical security systems preventing from pinching risk.
The main security devices are:

The emergency STOP

Located on the top part of the press, just under the control panel it switch off the machine.

To start a pressing cycle, it is necessary to activate the two green buttons within 0.5 sec with two hands (bimanual start)

When starting a pressing cycle the operator must take care that no one else is very near the heat plate.
The machine shall be operated by one operator only.

Checking the operation of the safety device :

- Users have to verify the proper functioning of the various safety devices daily.

2. INSTALLATION

USE BY QUALIFIED STAFF ONLY

- Remove the machine from its packaging and place it on its operating location.
- Remove all elements of the packaging: paper, cardboard, plastic films, wood, etc....
- Install the press on a special table that supports at least 300 kg.



- If necessary, start the machine level by acting on height adjustment feet.
- Electrically connect the press (400 Volt + Neutral + Earth / 50 or 60 Hertz)..
- Connect pneumatic press your compressed air system (3 mini bar, 10 bar). Connect the air filter on the controller (back of the machine).

V. DESCRIPTION OF THE OPERATING CYCLE

1. COMPLETE CYCLE

1. Turn the machine on by pressing the general switch on the back of the machine and, if necessary, unlock the emergency stop in front of the press.
2. Make sure the screen is on. It will show the factory presets,
3. Adjust the T° (2 zones) with the keypad (*according to the type of transfer you want to do*),
4. See SETTINGS following § **control display**
5. Tweak the pressing time with the keypad (*according to the type of transfer you want to do*),
6. See SETTINGS following § **control display**
7. Tweak the pressure with the regulator (*according to the type of transfer you want to do*) and verify it on the manometer
8. See SETTINGS following § **overview**
9. Place the article on the lower plate,
10. Adjust the transfer sheet,
11. When the drawer is closed, press the two bi-manual buttons simultaneously. Hold both buttons until the heating plate is in contact with the lower plate,
12. At the end of countdown, the heating plate goes back up,
13. Use the handle to slide the lower plate and remove the article,
14. Repeat the operation from the § above n° 10 (if the settings do not change otherwise § n°3).

2. CONTROL PANEL

Control display:

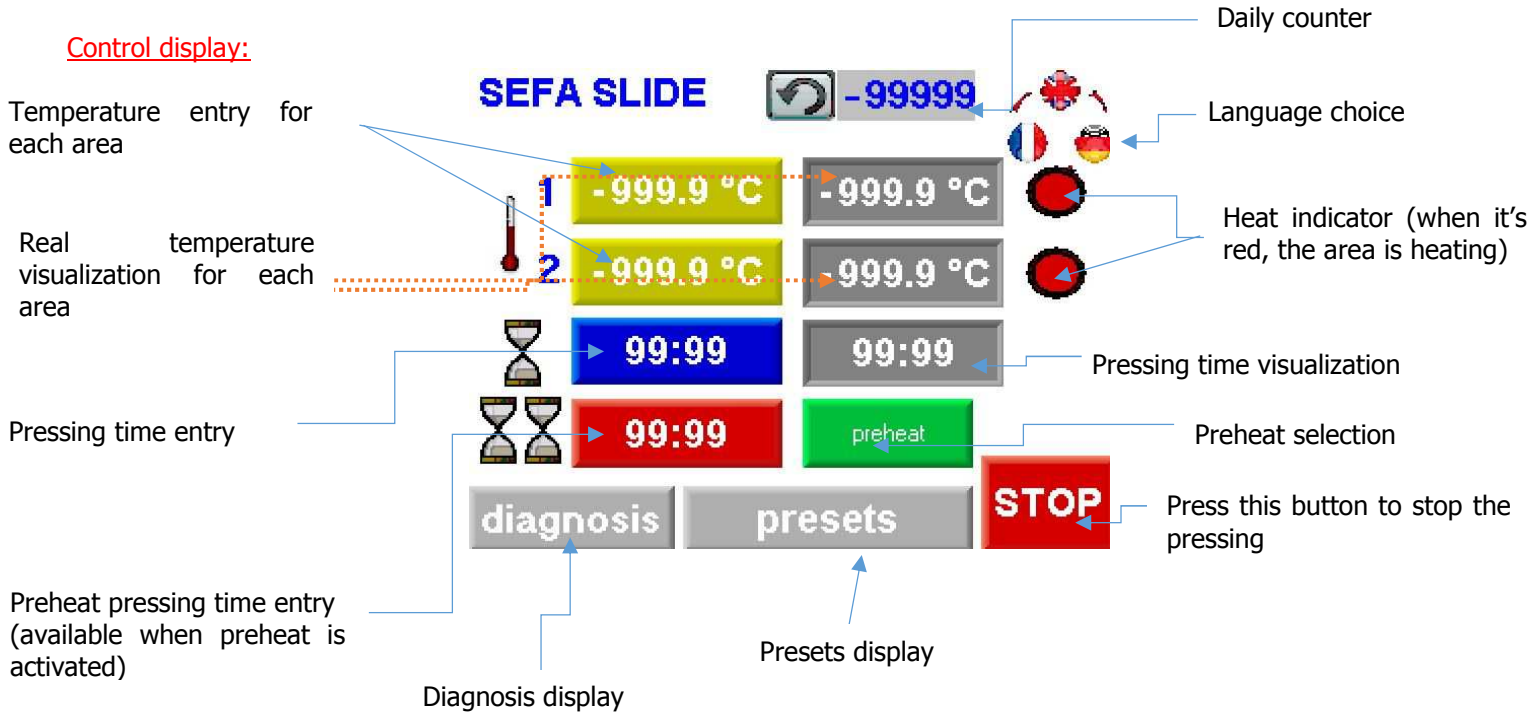

Diagnosis display :

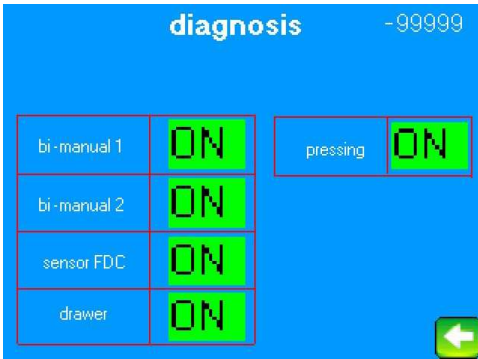

This display summarize all the inputs and outputs of the system.

This display will be helpful for diagnosis by phone with the SEFA technician.

The permanent counter is also on this display.

Presets display :



This automaton propose 4 pre-sets

For each one, you can choose the temperature for each area and the pressing time.

To activate the pre-set that you want, you need to push the button F1, F2, F3 or F4 existing on the display or in the back of the automaton.

VI. DIAGRAMS

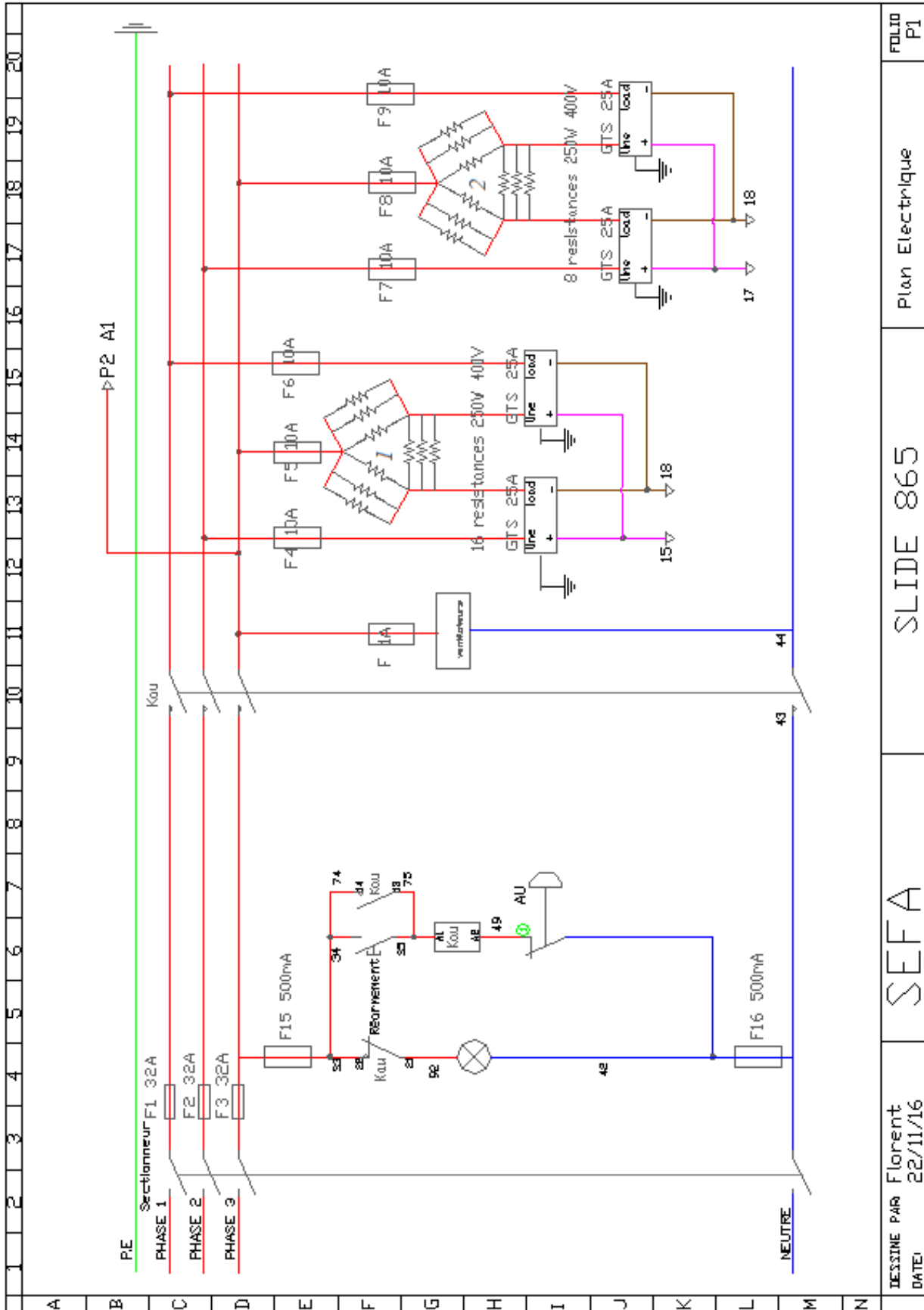

ISSINE PAR DATE:	Florent 22/11/16	SEFA	SLIDE 865	Plan Electrique	FOLIO P1
---------------------	---------------------	------	-----------	-----------------	-------------

PNEUMATIC DIAGRAM

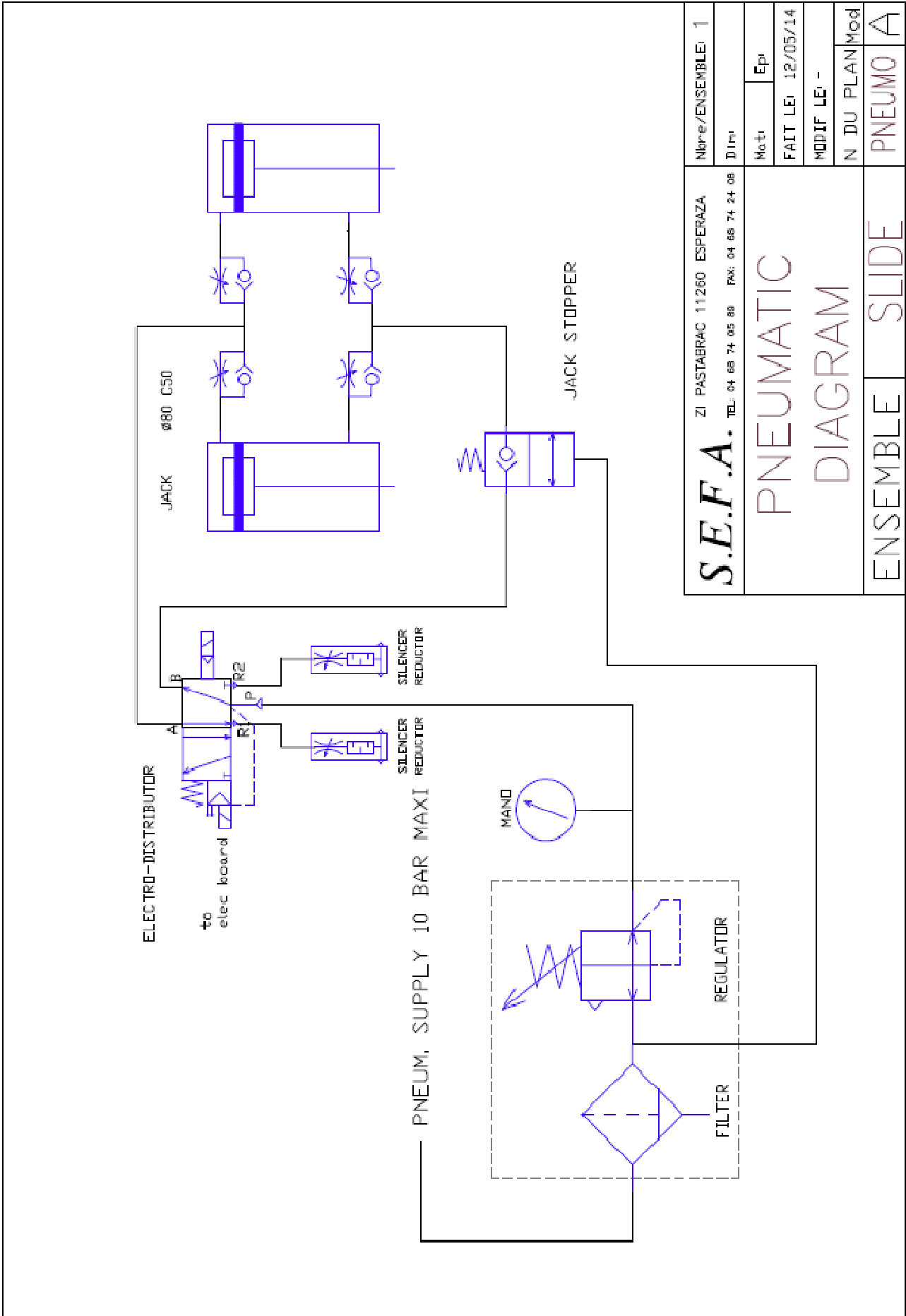

S.E.F.A. ZI PASTABRAC 11260 ESPERAZA TEL: 04 68 74 05 80 FAX: 04 68 74 24 08	Nbre/ENSEMBLE: 1	
	Dim	
PNEUMATIC DIAGRAM	Mot	Epi
	FAIT LE: 12/05/14	
	MODIF LE: -	
ENSEMBLE	SLIDE	N DU PLAN Mod
		PNEUMO A

VII. MAINTENANCE

USE BY QUALIFIED STAFF ONLY

**ANY SERVICING INTERVENTION MUST BE DONE WHEN THE MACHINE IS OFF AND LOCKED
(ELECTRIC AND PNEUMATIC ENERGIES UNPLUGGED)**

1. SERVICING

Heat transfer press SEFA ® require little maintenance. To ensure proper operation, follow the preventive guidelines listed below.

Do not heat objects that could damage or even cut the silicon rubber or damaging the Teflon surface

- | | |
|-------------------------------|--|
| DAILY : | Check the air intake on the right side, the purge filter if there is too much condensation. |
| MONTHLY : | Check and lubricate the axes if necessary. |
| ACCORDING TO THE USE : | Change felt every 6 months. |

2. POSSIBLE BREAKDOWNS

**ANY SERVICING INTERVENTION MUST BE DONE WHEN THE MACHINE IS OFF AND LOCKED
(ELECTRIC AND PNEUMATIC ENERGIES UNPLUGGED)**

SYMPTOMS	POSSIBLE BREACKDOWNS	REPAIRS
The machine doesn't start.	<ul style="list-style-type: none"> ➤ The wires are disconnected to the power socket. ➤ The switch is not activated. ➤ The fuses are out of order ➤ The display unit is faulty 	<ul style="list-style-type: none"> ➤ Check your network and if the machine is linked to it. ➤ Turn the main switch on. ➤ Check the fuses, change it if necessary. <i>For location see installation sheet</i> ➤ Check if the cables are properly connected at the automaton, otherwise it means the display is out of order.
The plate doesn't heat up	<ul style="list-style-type: none"> ➤ The resistance is out of order ➤ T° set point too low 	<ul style="list-style-type: none"> ➤ Verify the connections and the state of electric wires. To open the heat plate, get in touch with your reseller. ➤ To modify this value, see § control display).
The plate overheats	<ul style="list-style-type: none"> ➤ Sensor or electronic 	<ul style="list-style-type: none"> ➤ Get in touch you're your reseller.
The countdown doesn't start.	<ul style="list-style-type: none"> ➤ The sensor located on the pressing jack is not connected or defective. ➤ Problem on the motherboard 	<ul style="list-style-type: none"> ➤ Check its connections. ➤ Read the message displayed on the screen and refer to the card manual.
The plate doesn't go down	<ul style="list-style-type: none"> ➤ The push buttons aren't working. ➤ Leak on the jack ➤ The electro distributor is faulty ➤ The pressure is too low. 	<ul style="list-style-type: none"> ➤ Check the connections. ➤ Check the joints and all the unions. Get in touch with your retailer. ➤ Check its unions. Get in touch with your retailer to possibly change. ➤ Check the pressure of your network (> 3 bar)
Le plate doesn't go up	<ul style="list-style-type: none"> ➤ The electro distributor is faulty ➤ Leak on the jack 	<ul style="list-style-type: none"> ➤ Check its unions. Get in touch with your retailer to possibly change it. ➤ Verify the joints and all the unions. Get in touch with your retailer.

3. MAINTENANCE LOG

The control and maintenance operations indicated in this table must be done regularly so as to check the functioning state and the reliability of the press.

Date	Number of hours	Pressure control	Air filter control	Air Cylinder control	Rubber state	Resistors control	Changed parts	Observations

In order to facilitate the filling of the table, it may be useful to use the following code:
 C: Control N: Clean R: Replace